

19013376

**KIT POMPA SCARICO EVO AF (S500)
& LVS (S300 - S400)**

N°	RIF	DESCRIZIONE	QUANT.
1	12023666	TUBO SCARICO	1
2	12041924	CONDOTTO VASCHETTA-POMPA SCARICO	1
3	12009986	FASCETTA SENZA FINE DIN 3017 W2 32-50L	2
4	12094265	MOTOPOMPA 220V AC 1N 50/60HZ 37KW UL	1
5	12010021	GIUNTO GUIDA	1
6	12010023	FASCETTA 2032 INOX	1
7	12114815	SFIORATORE VERSIONE BD	1
8	12115850	GUARNIZIONE ANULARE Ø32 X 3,5MM	1
10	12094016	CONDOTTO ASPIRAZIONE LVS POMPA SCARICO HA	1
11	12115815	SFIORATORE_EVCO-21_B	1
12	12104085	GUARNIZIONE ANUL. DIAM. INT. 19,2X3	1
13	12000647	IMBALLAGGIO DI CARTONE 260X260X260	1
14	12126010	Manuale di istruzioni	1

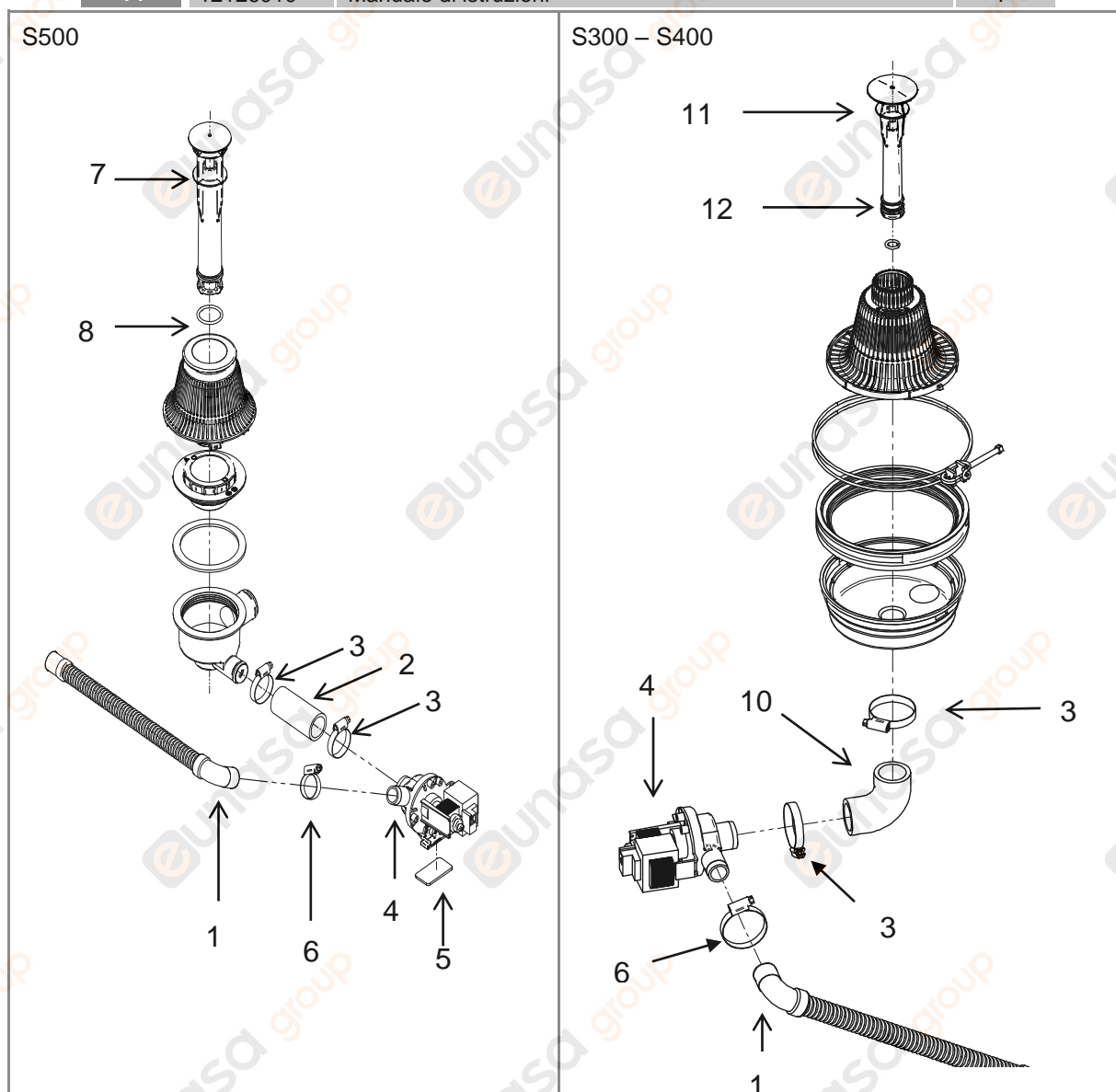

FIGURE



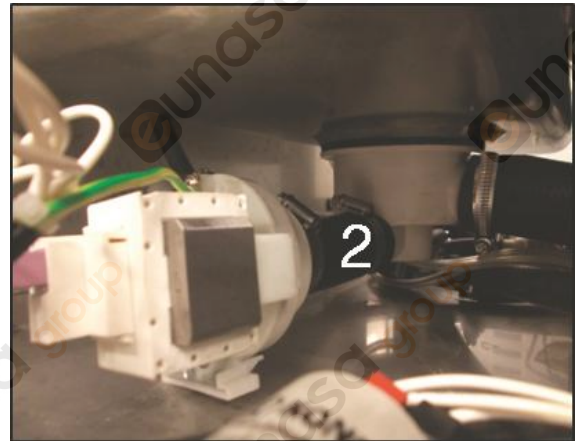
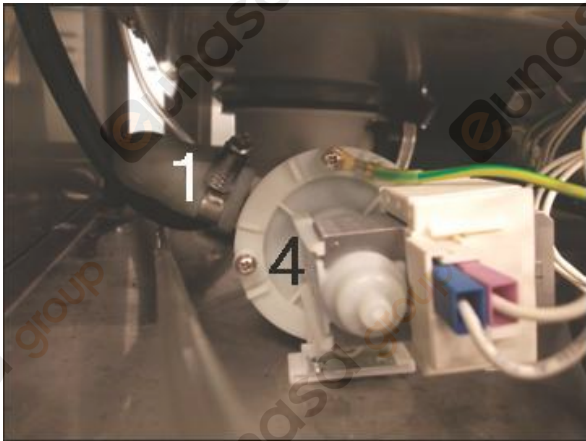

S500

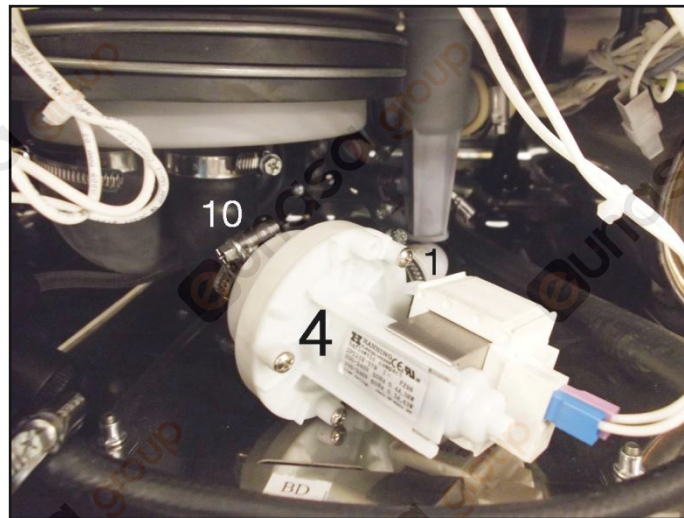

S300 - S400

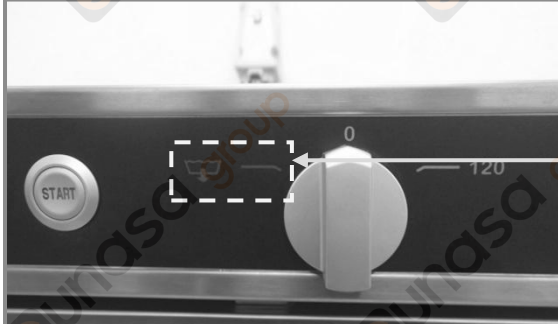

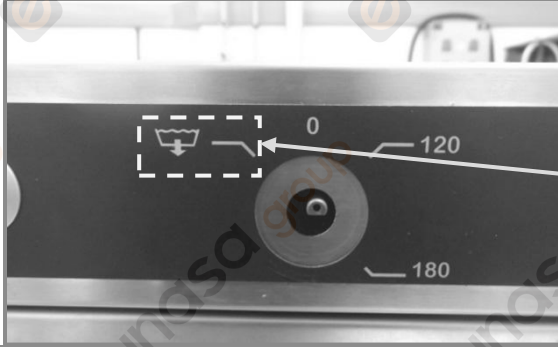
ESECUZIONE

	<p>La rondella ostruisce l'attività dello scarico.</p>
	<p>Tirare il pulsante di comando.</p>
	<p>Estrarre la rondella.</p>
	<p>Durante l'estrazione della rondella, l'attività dello scarico diventa visibile.</p>
	<p>Montare di nuovo il pulsante di comando.</p>